

## MTC疊加式單向節流閥



### ◆ 型號說明

MTC	-02	W	-K	-I	-20
型式	公稱通徑	控制油路	調節杆型式	控制型式	設計編號
疊加式單向節流閥	02: 1/4" 03: 3/8" 04: 1/2" 06: 3/4"	A: A孔 B: B孔 W: A&B孔	無標記: 未附塑膠旋鈕 K: 附塑膠旋鈕	無標記: 出口流量控制 I: 進口流量控制	20

### ◆ 油壓符號

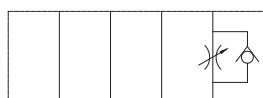

P T B A  
MTC-※A

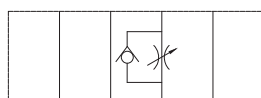

P T B A  
MTC-※B

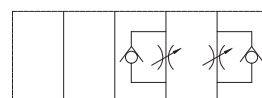

P T B A  
MTC-※W



P T B A  
MTC-※A-I

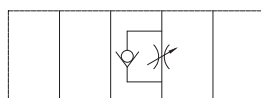

P T B A  
MTC-※B-I

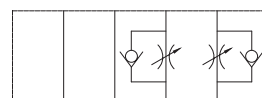

P T B A  
MTC-※W-I

### ◆ 性能規格

型式	最高工作壓力(bar)	額定工作壓力(bar)	額定流量(L/min)
MTC-02	315	250	35
MTC-03			70
MTC-04			190
MTC-06			300

D

疊加閥

MTC疊加式單向節流閥

## ◆ 特性曲線

測試條件：粘度35mm<sup>2</sup>/s 溫度：50°C

### ● 自由流之壓力降特性

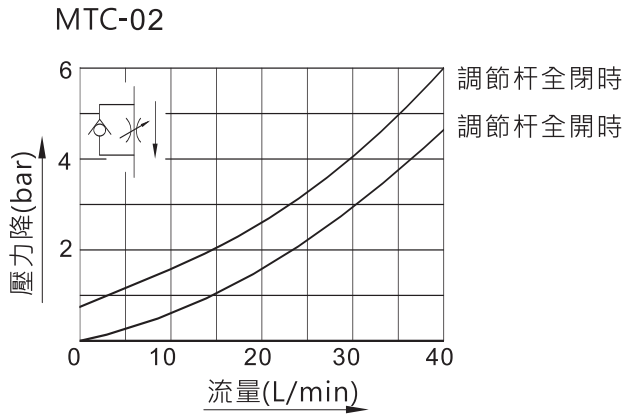

### ● 壓力降特性

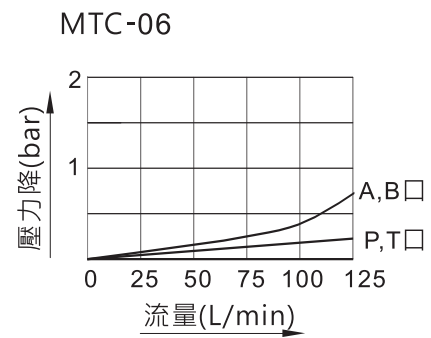
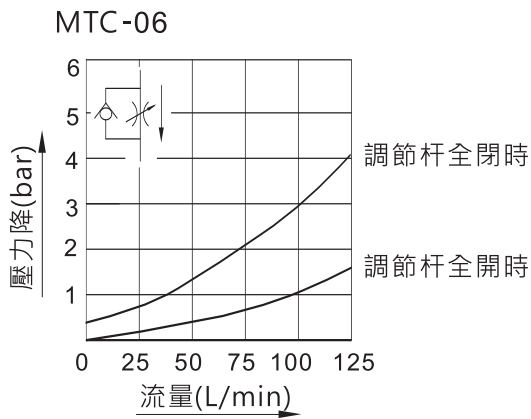
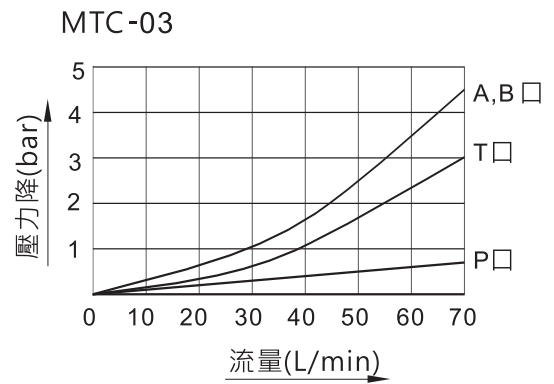
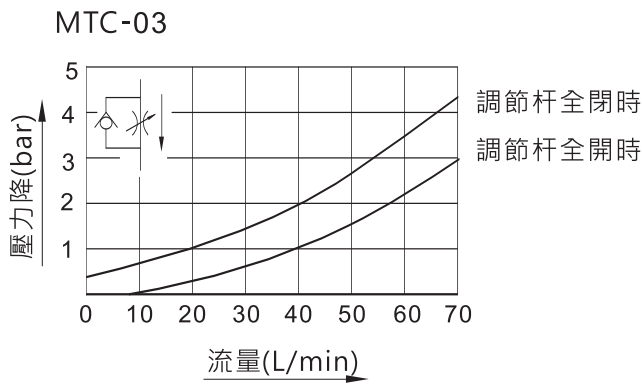
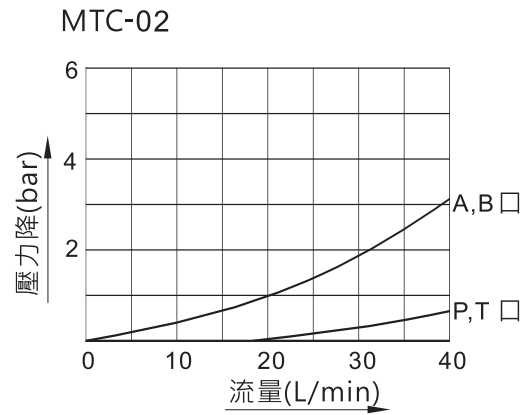

D

疊加閥

MTC疊加式單向節流閥

● 節流旋鈕開度—流量特性曲線  
MTC-02

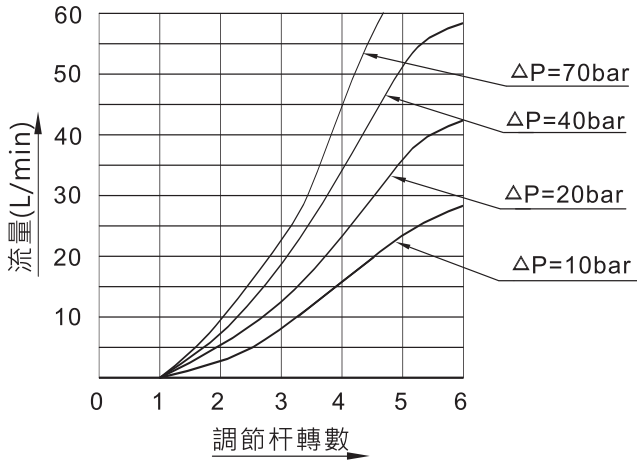

● 調節杆全開時壓力降特性  
MTC-02

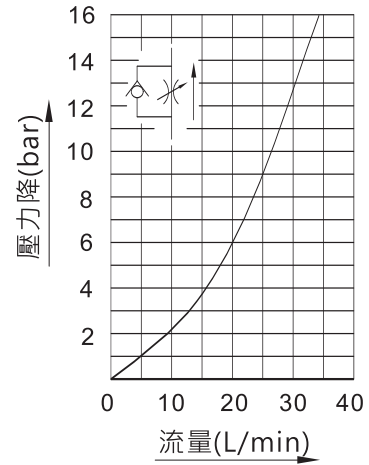

MTC-03

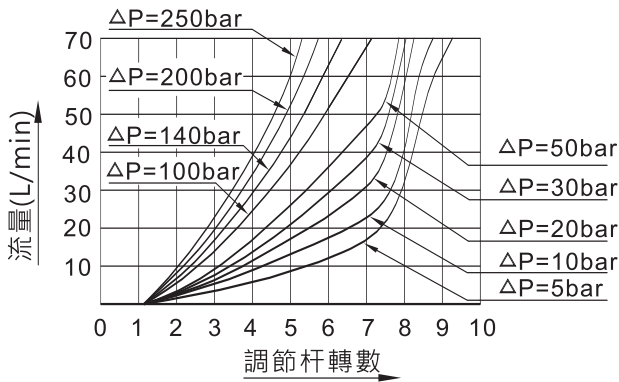

MTC-03

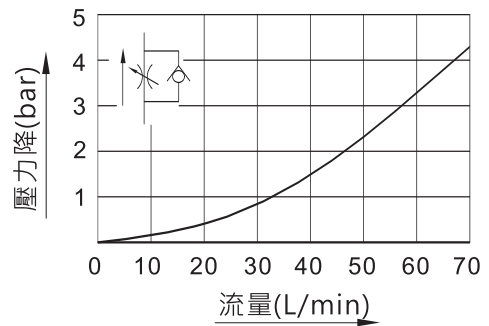

MTC-06

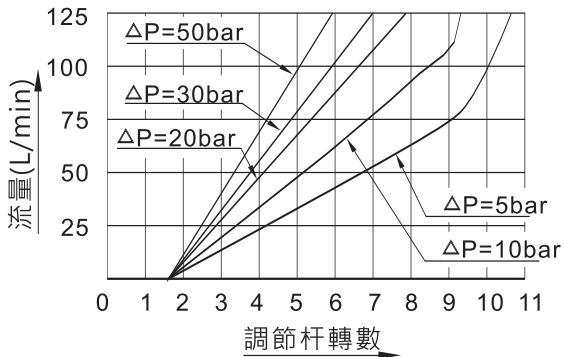

MTC-06

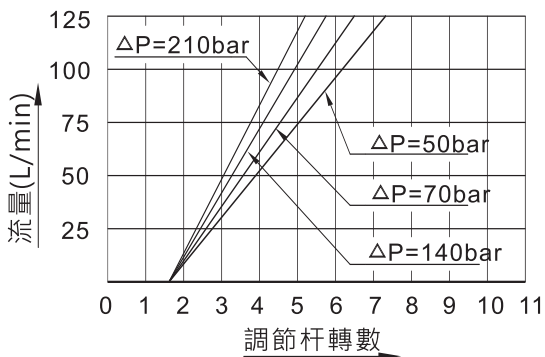
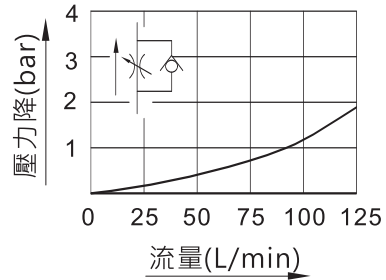

疊加閥

MTC疊加式單向節流閥

## ◆ MTC-02外形安裝尺寸

安裝面：ISO 4401-AB-03-4-A

單位：mm

安裝面詳盡尺寸，請參考附錄·[安裝面尺寸]部分。

### ● MTC-02A

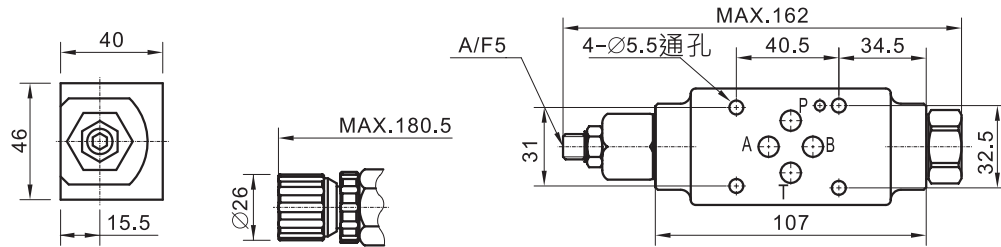

### ● MTC-02B

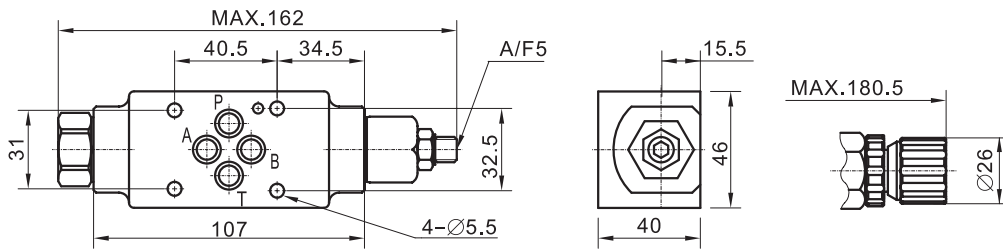

### ● MTC-02W

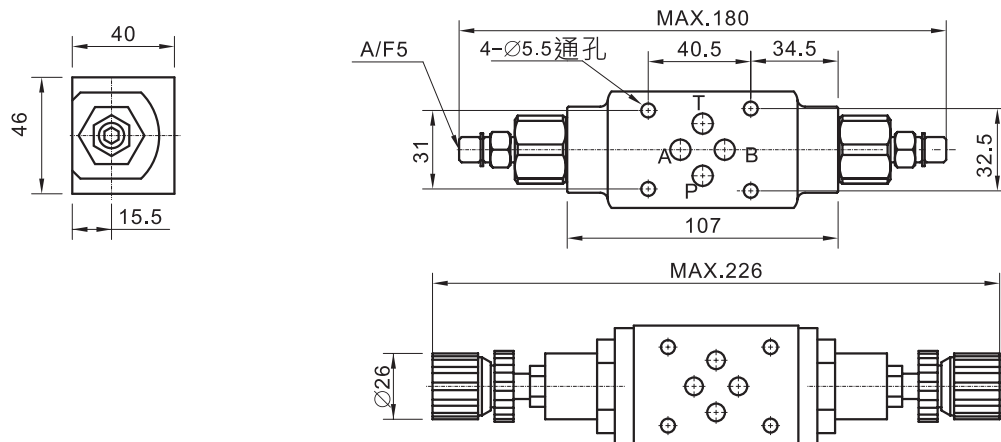

D

疊加閥

MTC疊加式單向節流閥

## ◆ MTC-03外形安裝尺寸

安裝面：ISO 4401-AC-05-4-A

單位：mm

安裝面詳盡尺寸，請參考附錄·[安裝面尺寸]部分。

### ● MTC-03A

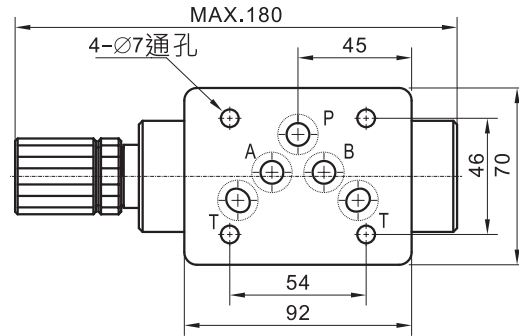
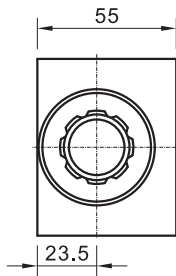

### ● MTC-03B

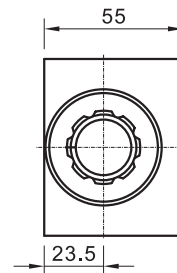
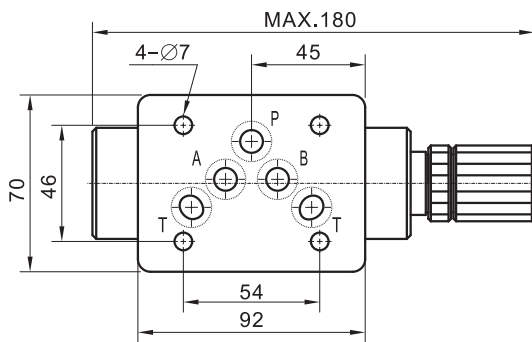

### ● MTC-03W

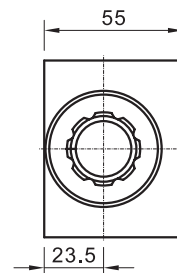
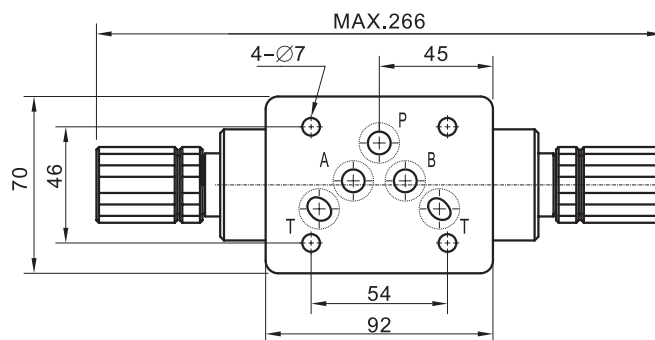

D

疊加閥

MTC疊加式單向節流閥

## ◆ MTC-04外形安裝尺寸

安裝面：ISO 4401-AD-07-4-A

單位：mm

安裝面詳盡尺寸，請參考附錄·[安裝面尺寸]部分。

### ● MTC-04A

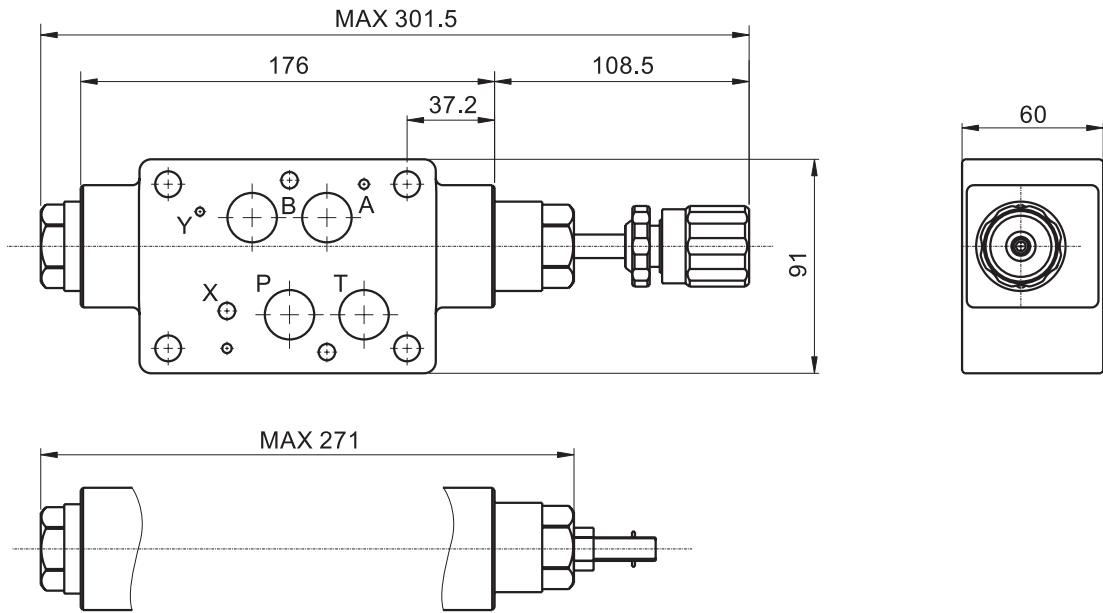

### ● MTC-04B

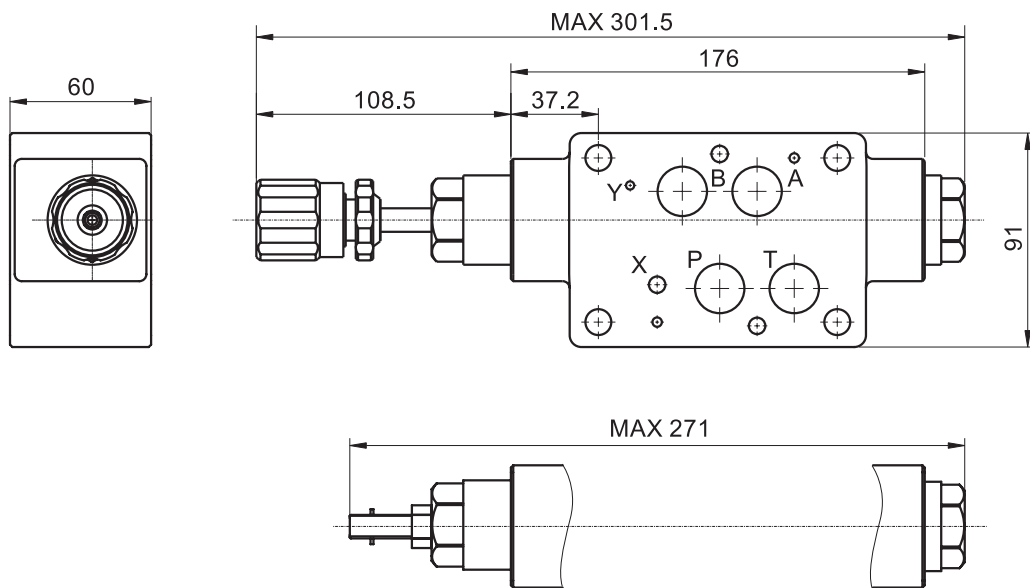

D

疊加閥

MTC疊加式單向節流閥

● MTC-04W

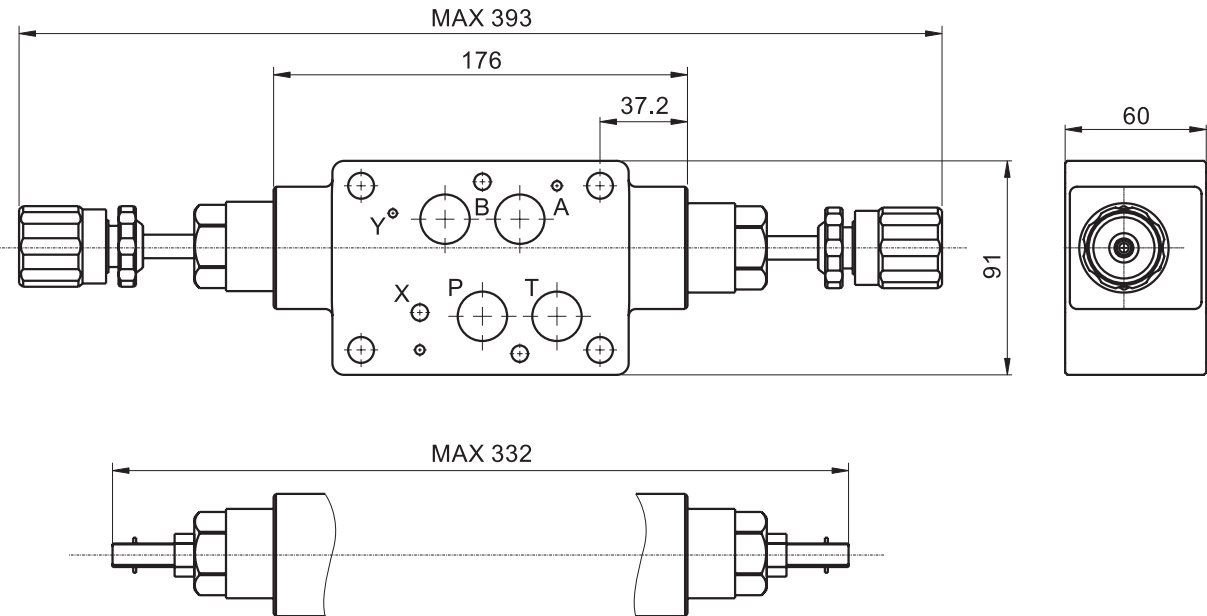

◆ MTC-06外形安裝尺寸

安裝面：ISO 4401-AE-08-4-A

單位：mm

安裝面詳盡尺寸，請參考附錄·[安裝面尺寸]部分。

● MTC-06A

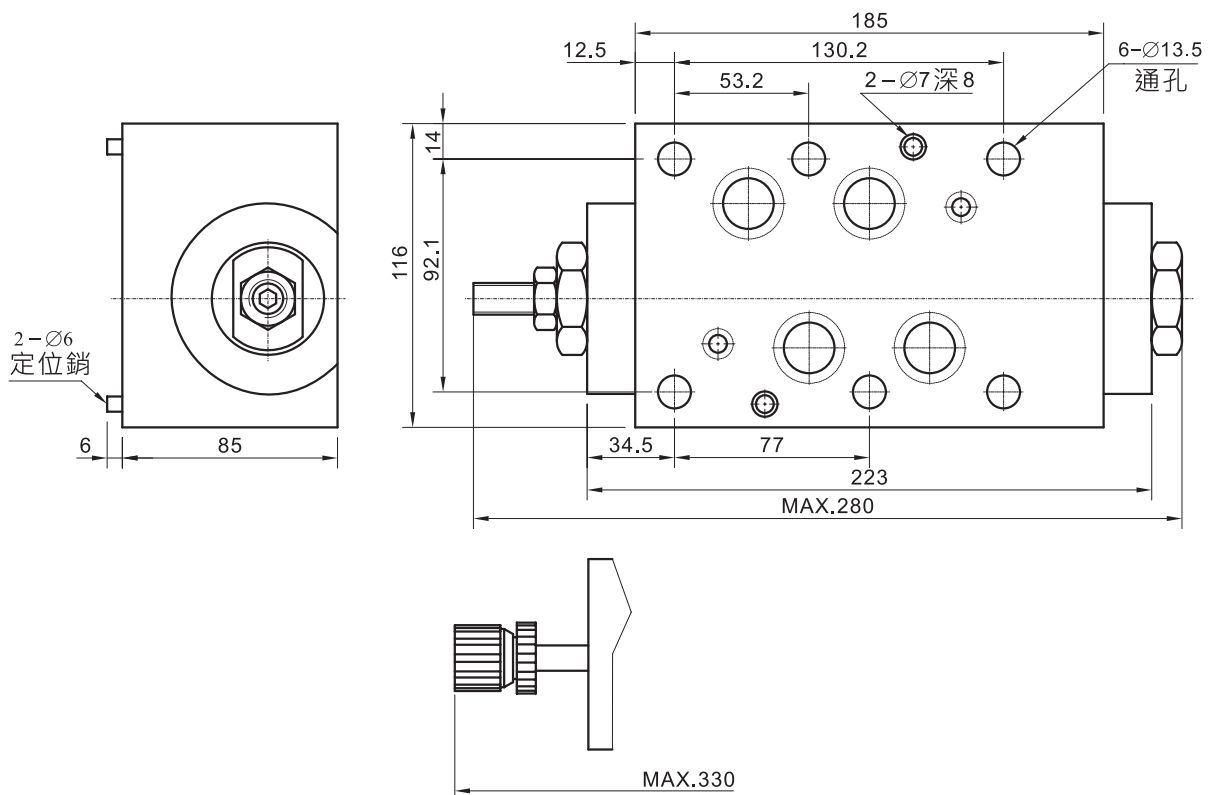

疊加閥

MTC疊加式單向節流閥

## ● MTC-06B

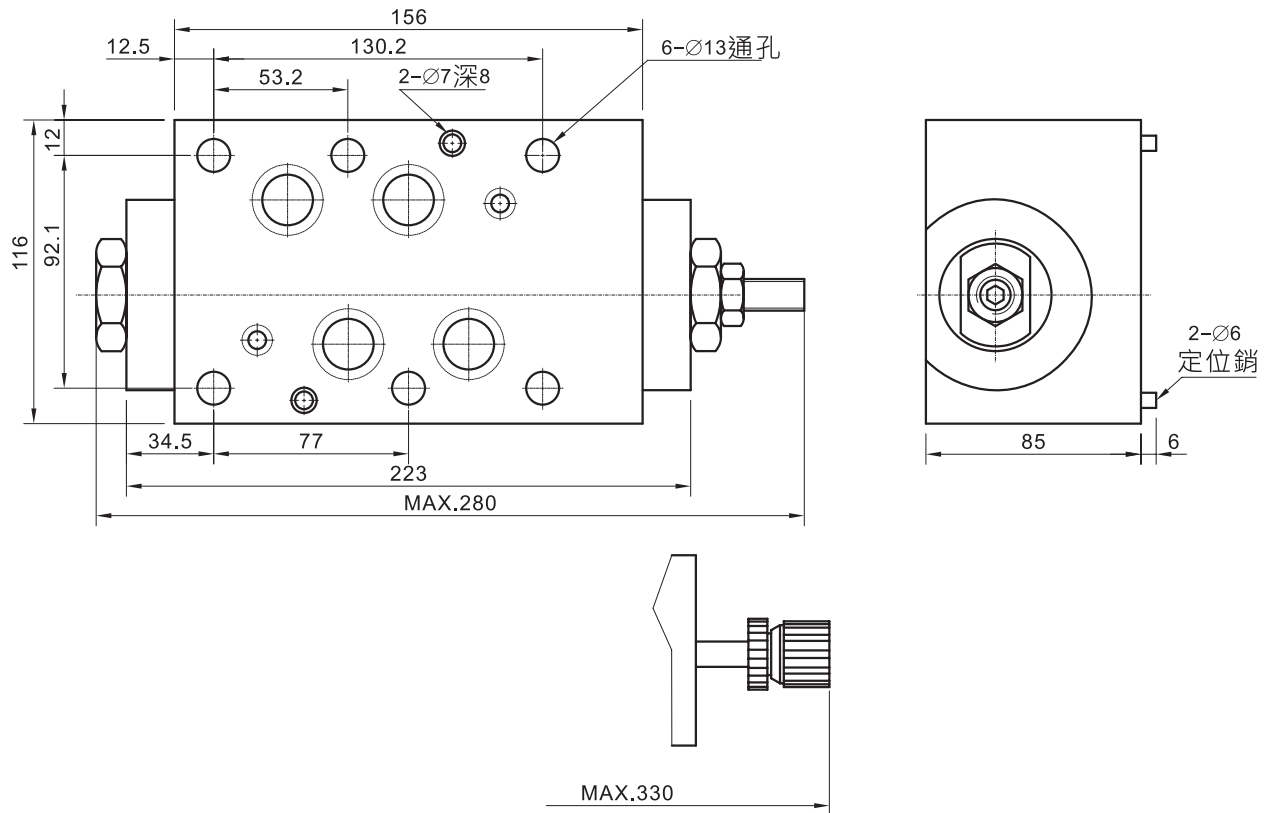

## ● MTC-06W

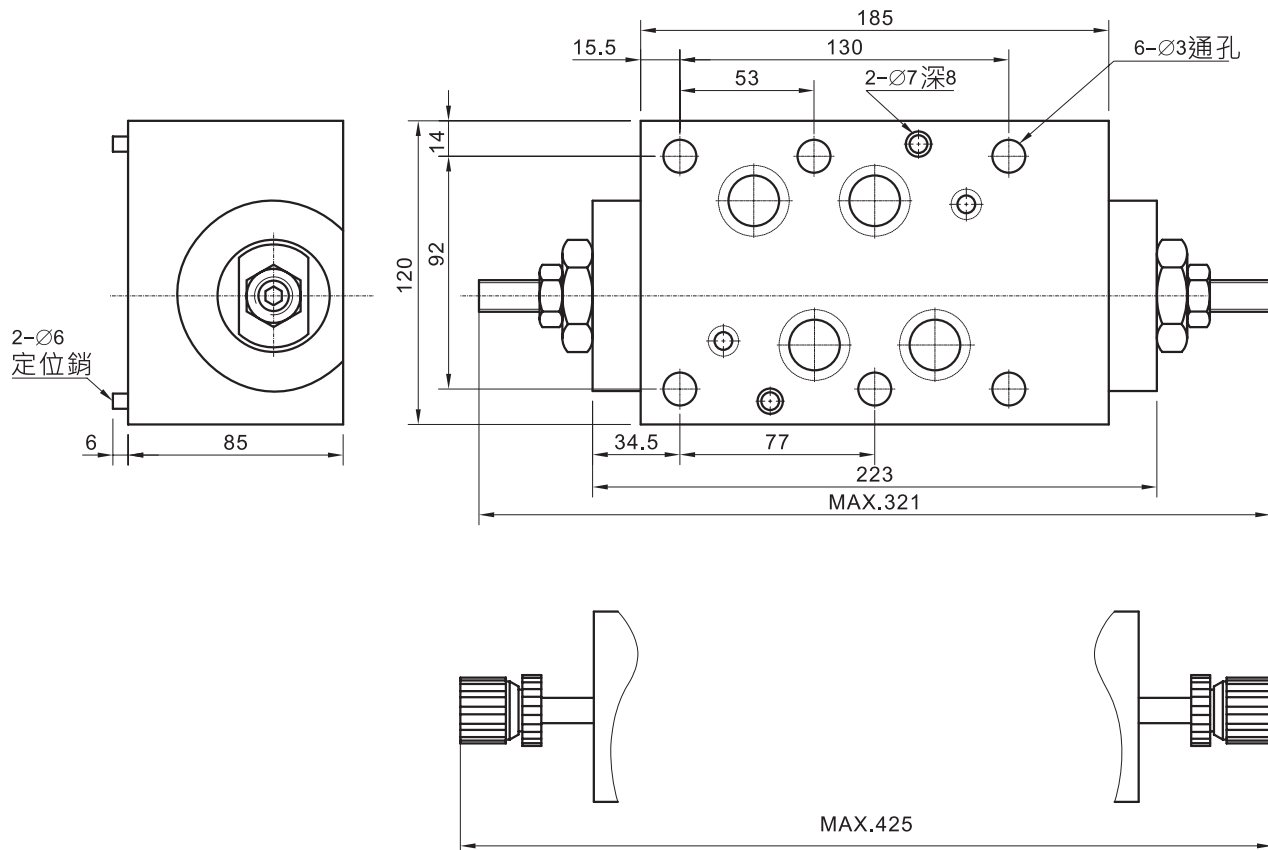

D

疊加閥

MTC疊加式單向節流閥